



Bison 80 User Manual Issue 1 - June 2004



Contents

1	Introducing Your Stairlift.....	2
2	Main Components	2
3	Description of Operation	3
3.1	Charging Your Stairlift	3
3.2	Safe Operation	4
4	Using Your Stairlift.....	5
5	Optional Items	6
5.1	Powered Swivel Seat.....	6
5.2	Remote Direction Controls	6
5.3	Remote Auto- Parking Control	6
6	Problems during Operation.....	7
6.1	Diagnostic Display	7
6.2	Hand Winding	8
7	Maintenance	8
7.1	Cleaning	8
7.2	Remote Control.....	8
7.3	Servicing	8



Bison 80

User Manual

Issue 1 - June 2004



1 Introducing Your Stairlift

Congratulations on becoming the owner of a Bison 80 Stairlift, which has been manufactured specifically to meet your requirements. It has a 12-month warranty and will provide you with many years of reliable service.

It is important for your safety that you study this manual to completely familiarise yourself with your Stairlift.

2 Main Components

The pictures in this manual show a Stairlift on the left-hand side of the stairs. Stairlifts on the opposite side of the stairs operate in exactly the same way.

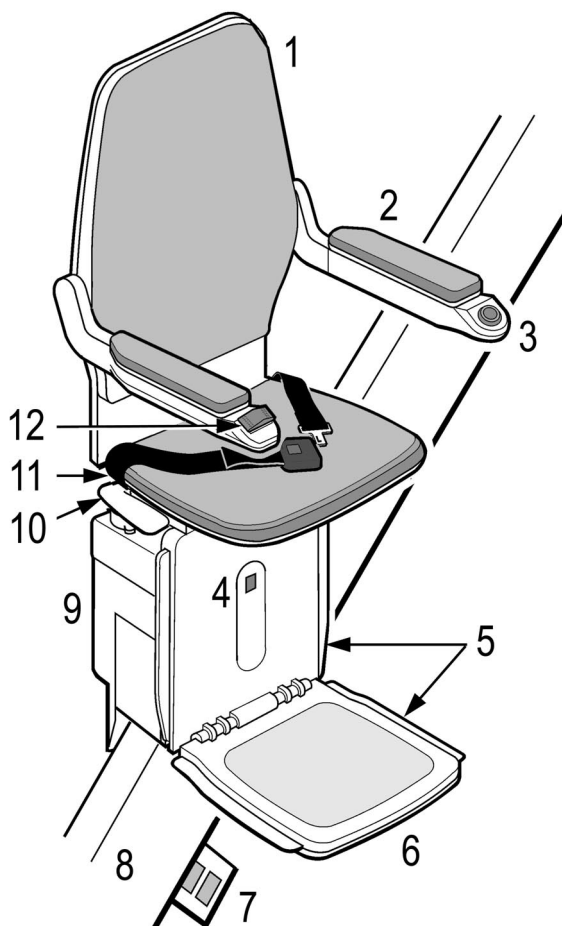

- 1 Seat
- 2 Armrest
- 3 On/Off Holding Switch
- 4 Status Indicator
- 5 Safety Edges
- 6 Footrest
- 7 Charging Points
- 8 Rail
- 9 Carriage
- 10 Seat Swivel Release Paddles
- 11 Seat Belt
- 12 Direction Controller



Bison 80

User Manual

Issue 1 - June 2004



3 Description of Operation

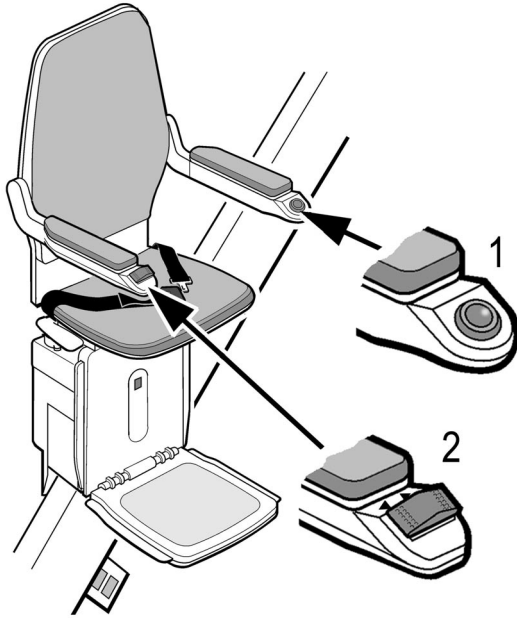

Your Stairlift is switched on and off using the On/Off Holding Switch (1).

The Stairlift is moved up and down the stairs by the user operating the Direction Controller on the armrest (2).

When not in use please ensure that the seat belt is kept clear of the rail.

3.1 Charging Your Stairlift

The Stairlift batteries are recharged from charging points when the Stairlift is in its parked position at the top and bottom of the stairs. The charging points are connected to the mains electricity supply through a transformer.

If there is a mains electricity supply failure, or if the supply to your Stairlift is switched off, it will continue to operate for several journeys. However, the batteries will eventually lose their charge and the Stairlift will not operate.

If the batteries are not being recharged you will see this flashing symbol, on the fault indicator, and hear a bleep alarm.



To ensure that the batteries are kept fully charged, the mains electricity supply should always be switched on and the Stairlift parked on its charge points.

If the batteries have lost their charge because the mains electricity supply has been switched off, or interrupted, allow them to recharge before using the Stairlift. This symbol will stop flashing when the Stairlift is ready for use.

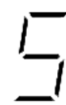



Bison 80

User Manual

Issue 1 - June 2004



3.2 Safe Operation

WARNING

- Do not allow children to play with the Stairlift.
- Do not exceed the **safe weight limit** the Stairlift is designed to carry (see the label underneath the seat).
- Always use the seatbelt.

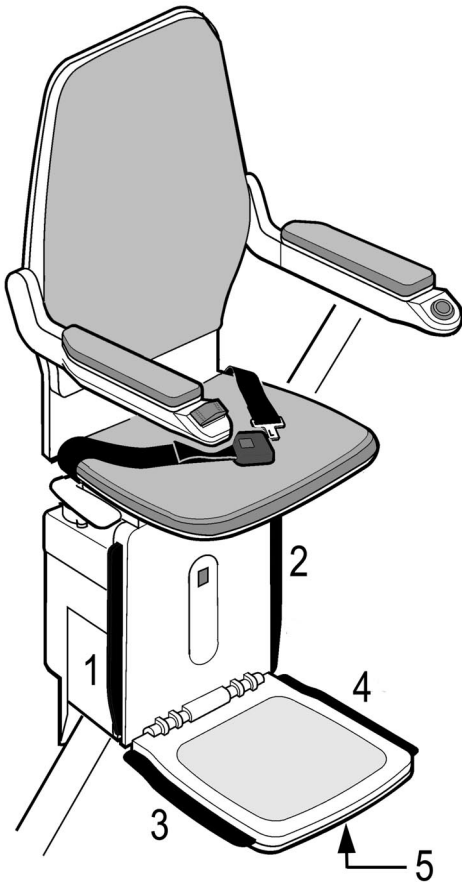

Before operating your Stairlift, ensure that there are no obstructions on the staircase. The Stairlift is fitted with five safety edges:

1 & 2 - each side of the carriage.

3 & 4 - each side of the footrest.

5 - under the footrest.

If these encounter any obstruction, the Stairlift will stop immediately. Move the Stairlift back in the opposite direction and remove the obstruction.



Bison 80

User Manual

Issue 1 - June 2004



4 Using Your Stairlift

- 1 Lower the footrest.
- 2 Lower the seat and arms
- 3 Hold down one of the swivel paddles and swivel the seat until it locks into its operating position as shown (at the top of the stairs only).
- 4 Sit in the seat and fasten the seatbelt.
- 5 Switch the Stairlift on with the On/Off Holding Switch on the arm rest, its green lamp will illuminate, indicating the power is on.
- 6 Press the Direction Controller in the direction of travel.
- 7 After a short delay the Stairlift will beep and begin to move, slowly at first, until it reaches full speed. Keep the Direction Controller pressed down continually throughout the journey. When the seat is passing over or around certain bends it will slow down, this is for your comfort and safety.
- 8 The Stairlift will automatically slow down and stop when it has reached the end of its travel.
- 9 Switch the Stairlift off using the On/Off Holding Switch on the arm rest (5)
- 10 To swivel the seat, push down a seat paddle and rotate the seat until it locks into position, partly or fully around (at the top of the stairs only).
- 11 It is now safe to undo the seat belt and alight from the Stairlift.
- 12 The arms, seat and footrest may now be folded up.

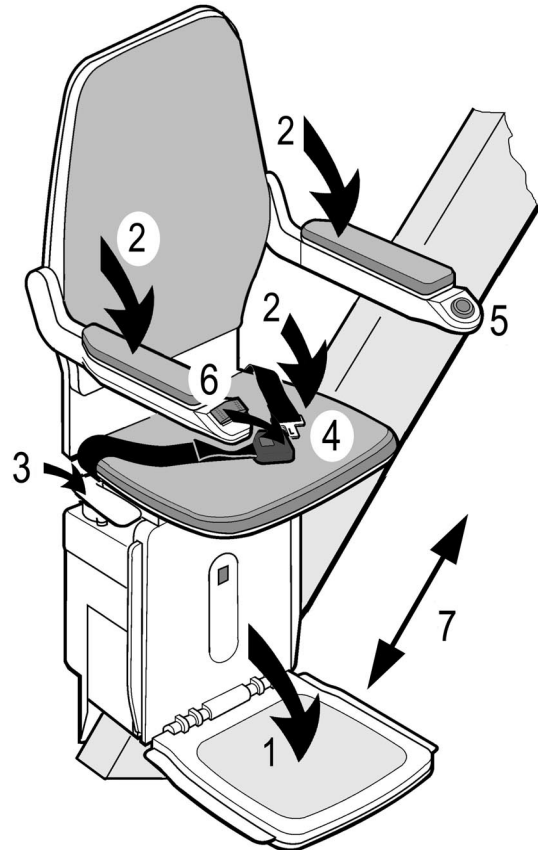



Bison 80

User Manual

Issue 1 - June 2004



5 Optional Items

5.1 Powered Swivel Seat

If a powered seat is fitted, (at the top of the stairs only) continue to hold down the Direction Controller (1). After the Stairlift stops moving, the seat will begin to swivel round automatically.

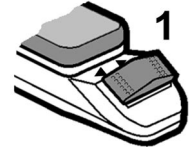



Switch the Stairlift off using the On/Off Holding Switch (2) on the arm rest. It is now safe to undo the seat belt and alight from the Stairlift.



5.2 Remote Direction Controls

If the Stairlift has remote controls, it must be in its correct operating condition, with the seat facing forward and switched on with the On/Off Holding Switch, before using them.

These controls can be used to call the Stairlift. Press the  or  buttons continuously until the Stairlift stops at the end of its travel. Do not leave the Stairlift parked part way up the stairs because the batteries will not be re-charged in this position.

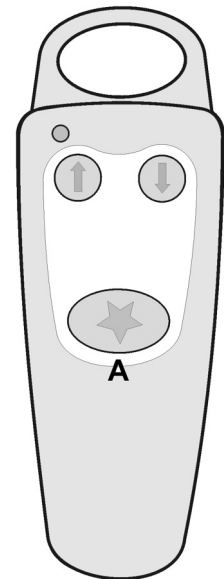

5.3 Remote Auto- Parking Control

The arm rests and seat must be folded manually prior to operating the Autopark feature. Press and hold the Autopark button (A) continuously to send the Stairlift to its charge point and operate any powered options.



Bison 80

User Manual

Issue 1 - June 2004



6 Problems during Operation

6.1 Diagnostic Display

When the Stairlift is switched on the Diagnostic Display underneath the seat is illuminated. During normal operation it will display these symbols:

	Stairlift is in Standby Condition and ready to use.
	Stairlift is moving up the rail.
	Stairlift is moving down the rail.
	Stairlift is at its correct parked position.
	Batteries are fast charging (small light on).
	Batteries are trickle charging (small light flashing).

If the Stairlift will not operate or stops during operation check the diagnostic display.

	The Seat is swivelled away from its operating position.
	The Hinged Rail (when fitted) is not down in its operating position.
	The Seat or Footrest are not down in their operating positions.
	A sensitive safety edge has been activated - check for obstructions.
	Conflicting signal between the Stairlift Direction Controller and the Remote Direction Controls.
	There is insufficient charge in the batteries to allow the lift to complete a full journey. Leave on charge until the Standby symbol appears.

(Flashing Display and Bleep Alarm)



Batteries are not being charged - check mains electricity supply is switched on and the Stairlift is parked on its charge points.

If this symbol is displayed do **NOT** use the hand winder in the down direction as this could damage the Stairlift. Contact your Stairlift Supplier immediately.

If any other symbols are displayed you should contact your Stairlift Supplier



Bison 80

User Manual

Issue 1 - June 2004



6.2 Hand Winding

In an emergency the Stairlift may be hand wound to clear any obstruction.

Caution



If this symbol is displayed do **NOT** hand-wind the Stairlift in the down direction because this could damage it.

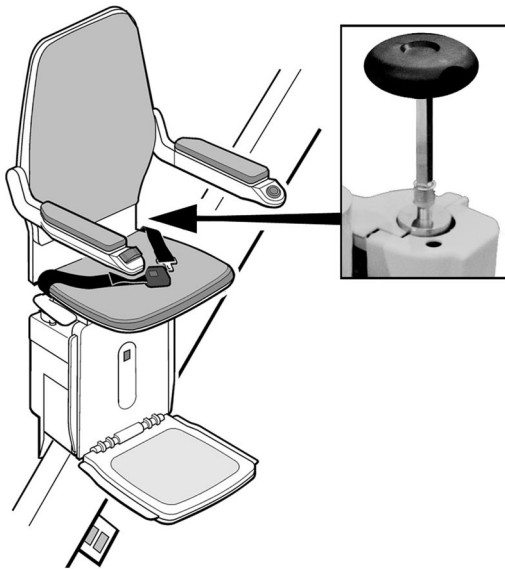

- 1 Ensure the Stairlift is switched off with the On/Off Holding Switch.
- 2 Remove the round cover on top of the carriage (marked with a **Emergency Handwind** label).
- 3 Fit the hand winder onto the hexagonal spindle and follow the instructions on the label inside the round cover.

7 Maintenance

7.1 Cleaning

Wipe the seat, carriage and rail down with a dry cloth.

7.2 Remote Control

Replace the remote control batteries annually.

7.3 Servicing

It is recommended that your Bison 80 Stairlift installation be serviced every 12 months by your Stairlift Supplier to ensure it remains safe and reliable.

Your Stairlift is designed to operate smoothly and quietly. The equivalent continuous A-Weighted sound pressure level of this equipment does not exceed 70 db (A).